

## ※ ISC3806 SERIES

Shaft diameter  $\Phi 6$  mm or  $\Phi 8$  mm , clamping flange, housing diameter  $\Phi 38$  mm.

Low price at high performance, small volume, light weight, easy for installing

### Applications:

Measure the distance, stop dog positioning, curtained door, textile machines



### Output waveform

90° Output phase difference, CW rotation (CW rotation as seen from fit surface)

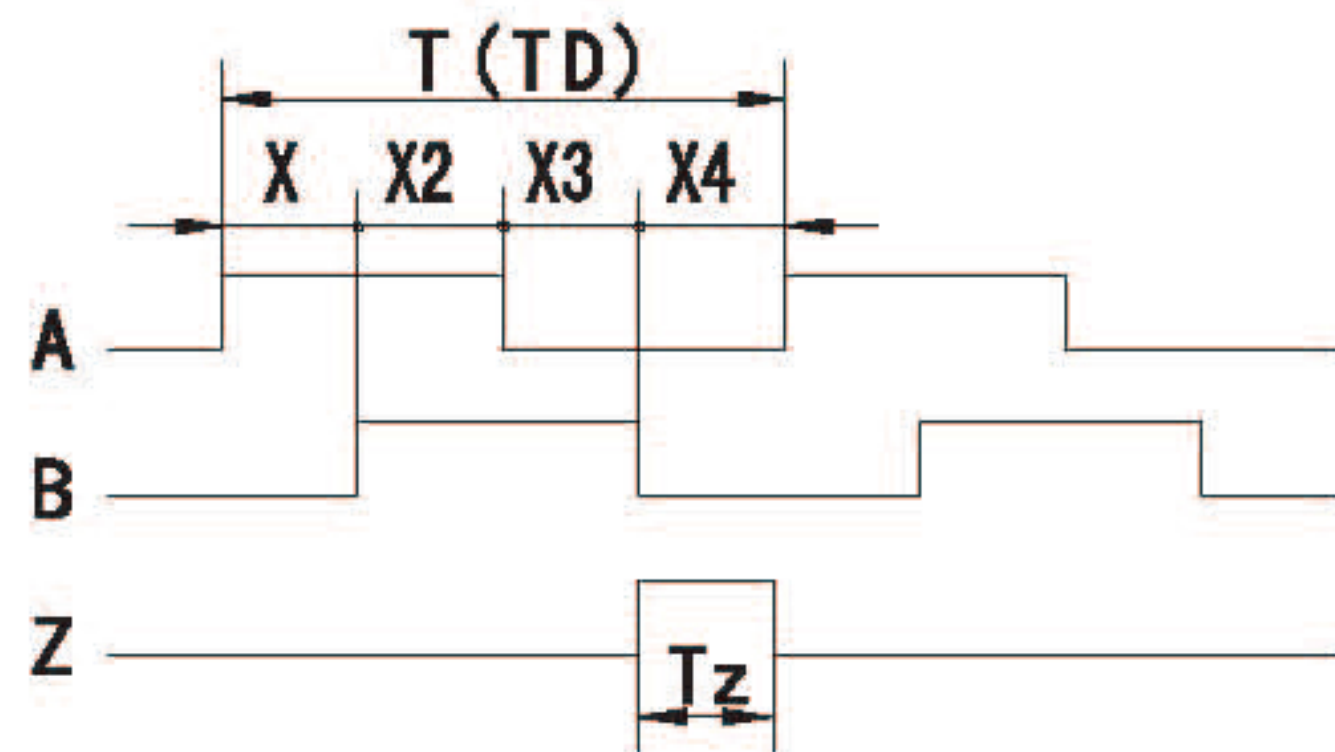

Square-wave accuracy:  $X_1 + X_2 = 1/2T \pm 1/12T$   
 $X_3 + X_4 = 1/2T \pm 1/12T$

Pitch error of period:  $\pm 0.01T$

Pitch error of phase position:  $\leq 1/18T$

Z phase:  $T_z = 1/4T$  (1T, 1/2T, 1/4T...)

Period of pulses:  $T = 360^\circ / N$  (N : output pulses)

Signal accuracy:  $X_n = 1/4T \pm 1/12T$  (n=1, 2, 3, 4)

A leads B clockwise when viewing the encoder shaft end,  
The position of Z phase against A, B phase is not specified.

### Terminal assignment

Signal	+5V	0V	SIG A	SIG $\bar{A}$	SIG B	SIG $\bar{B}$	SIG Z	SIG $\bar{Z}$	Shield
Cable Color	Red	Black	Green	Brown	White	Grey	Yellow	Orange	N.C

Note: Shield is attached to connector housing, One meter cable lengths (other cable lengths on order).

### Ordering code

ISC3806	—	H03	G	600	BZ3	—	5-12	C
Series		Sequence Number	Connection	Number of Pulses	Output Signals		Supply Voltage	Output Circuit

Series: ISC3806, Radial cable: G, Number of pulses: 600 p/r, Output signals: ABZ,  $T_z = 1/4T$ , Supply voltage: 5-12V DC, Output circuit: Open collector NPN, Record: ISC3806-H03G600BZ3-5-12C

### Dimensions

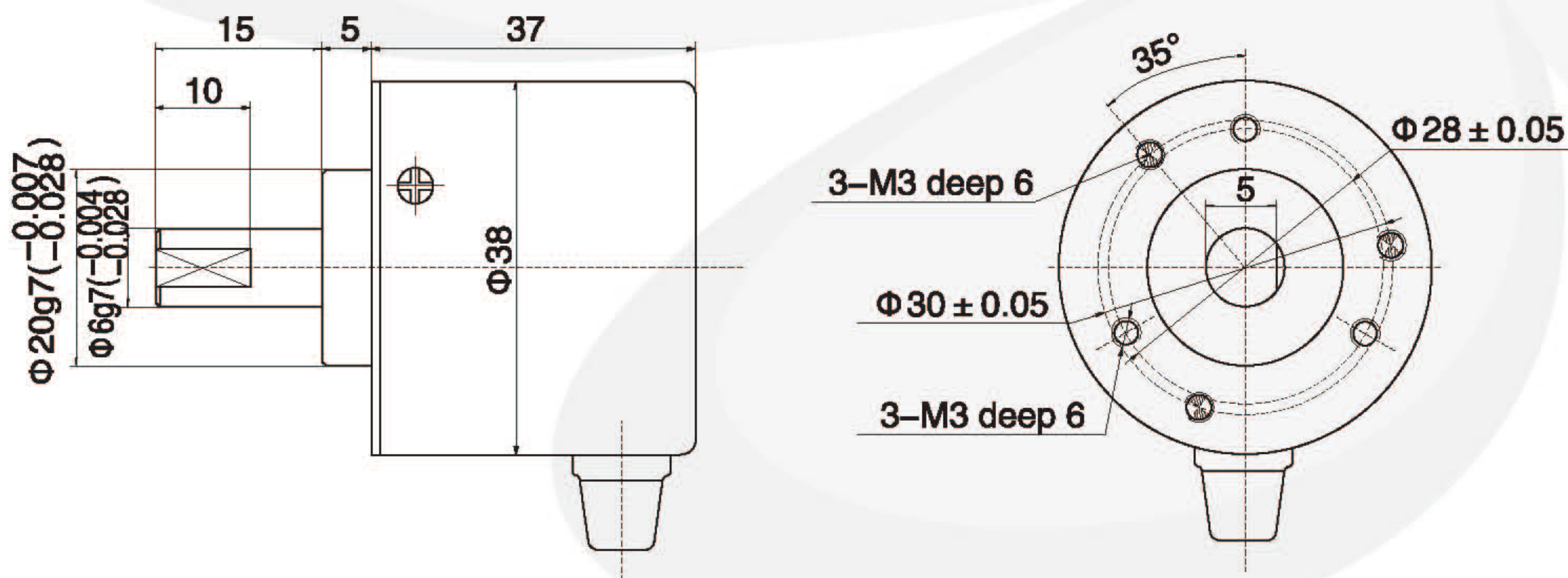

### TECHNICAL SPECIFICATIONS

ELECTRICAL SPECIFICATIONS	
Output wave	Square wave
Output signals	A, B, Z, (Line driver output A, $\bar{A}$ , B, $\bar{B}$ , Z, $\bar{Z}$ phase)
Current consumption	$\leq 120$ mA
Response Frequency	0~100KHz
Output phase difference	$90^\circ \pm 45^\circ$
Supply voltage	5V DC, 5-12V DC, 12-24V DC
Signal level	$V_H \geq 85\%V_{CC}$ , $V_L \leq 0.3V$
Number of pulses	10, 15, 20, 30, 40, 50, 60, 100, 120, 125, 150, 180, 200, 240, 250, 256, 300, 360, 400, 480, 500, 512, 600, 720, 740, 800, 900, 960, 1000, 1024, 1200, 1250, 1440, 1500, 1800, 2000, 2048, 2500 (Other number of pulse available on request)
Output circuit	Open collector NPN, Push pull, Line driver, Voltage
MECHANICAL SPECIFICATIONS	
Speed without sealing	5000rpm
Rotor moment of inertia	Appr. $3.5 \times 10^{-4}$ Kg $m^2$
Starting torque without sealing	$\leq 1.5 \times 10^{-3}$ Nm (+25°C)
Maximum load permitted on shaft	Radial 20N, Axial 10N
Shock resistance	980m/s $^2$ , 6ms, 2 times each on XYZ
Vibration proof	50m/s $^2$ , 10~200Hz, 2 hours each on XYZ
Working life	MTBF $\geq 25000$ h (+25°C, 2000rpm)
Weight	Appr. 130g (with 0.5 meter cable)
ENVIRONMENTAL SPECIFICATIONS	
Working humidity	30~85% (No condensation)
Storage temperature	-40°C~100°C
Working temperature	-25°C~85°C
Protection class	IP54