



User Manual for  
Closed Loop Stepper Drive

# Y Series Closed Loop Driver

Version 1.0

## 1 Introductions & Features

The Y series closed-loop drivers are divided according to the driving power, which are CL57Y, CL86Y. This Closed Loop Stepper Drive offers an alternative for applications requiring higher performance and higher reliability than open loop stepper system, and it remains cost-effective. The matched stepper motors are NEMA17, 23 and 24 combined with an internal encoder which is used to close the position, velocity and current loops in real time. Its great features of quicker response and no hunting make this closed loop stepper drive ideal for applications such as bonding and vision systems in which rapid motions with a short distance are required and hunting would be a problem. And it is ideal for applications where the equipment uses a belt-drive mechanism or otherwise has low rigidity and you don't want it to vibrate when stopping. And features are showing below:

- A new generation of 32-bit DSP control technology
- Input voltage range:DC24~50V,AC20~80V/DC30~110V
- The highest impulse response frequency is 200KHz
- Low torque attenuation, up to 3000rpm
- Built-in positioning and alarm output for easy detection and control
- Intelligently regulate current, reduce vibration, noise and heat, and increase efficiency by 35%
- With single and double pulse selection function, the factory default is: pulse + direction control
- Excellent high-speed performance and rigidity, perfect combination of servo and stepping advantages

## 2 Specifications

### 2.1 Electrical Specifications

Parameters	CL57Y			
	Min	Typical	Max	Unit
Output Peak Current	0	-	5	A
Input Voltage	24	36	50	VDC
Logic Signal Current	7	10	16	mA
Pulse Input Frequency	0	-	200	kHz
Pulse Width	2.5	-	-	μS
Minimal direction setup	2.5	-	-	μS
Isolation Resistance	500			MΩ

Attention: Please read this manual carefully before using the drive.

[www.oystepper.com](http://www.oystepper.com)

### 2.2 Mechanical Specifications(unit: mm [1inch=25.4mm])

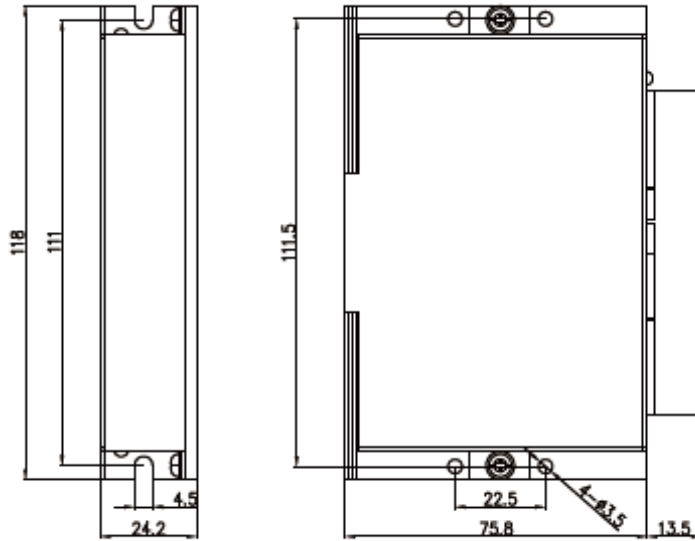

Figure 1: Mechanical specifications  
Recommend use side mounting for better heat dissipation

### 2.3 Electrical Specifications

Parameters	CL86Y			Unit
	Min	Typical	Max	
Output Peak Current	0	-	6	A
Input Voltage	20 (30)		80 (110)	VAC(VDC)
Logic Signal Current	7	10	16	mA
Pulse Input Frequency	0	-	200	kHz
Pulse Width	2.5	-	-	μS
Minimal direction setup	2.5	-	-	μS
Isolation Resistance	500			MΩ

### 2.4 Mechanical Specifications(unit: mm [1inch=25.4mm])

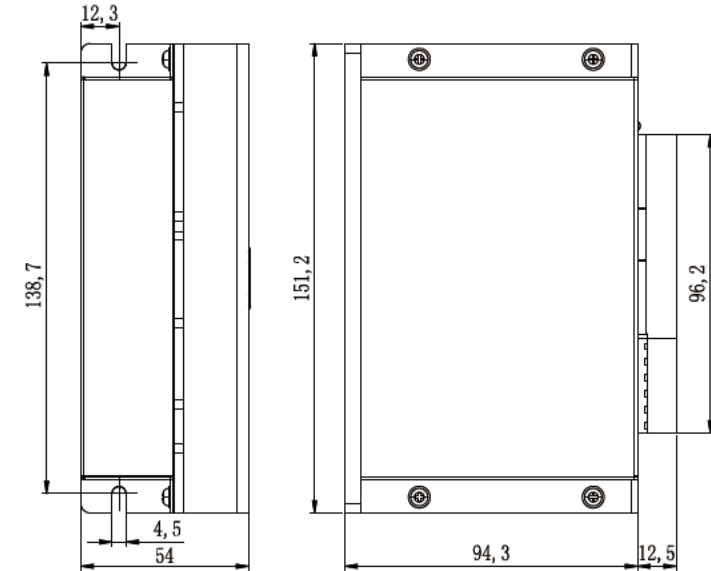

Figure 2: Mechanical specifications  
Recommend use side mounting for better heat dissipation

## 3 Pin Assignment and Description

### 3.1 Connector P1 Configurations

Pin Function	Details
PU+	Connected to the signal power supply, +5~+24V can be driven
PU-	The falling edge is valid and the pulse goes one step when the pulse goes from high to low. Requirements: Low level: 0~0.5V, high level 5~24V, pulse width greater than 2.5 microseconds.
DR+	Connected to the signal power supply, +5~+24V can be driven
DR-	Used to change the direction of the motor. Requirements: Low level: 0~0.5V, high level 5~24V, pulse width greater than 2.5 microseconds.
MF+	Connected to the signal power supply, +5~+24V can be driven

MF-	When it is active (low level), the motor coil current is turned off, the driver stops working, and the motor is in a free state.
Pend+	When the drive has finished a given pulse, the in-position signal is valid (output optocoupler is on). Pend+ is connected to the pull-up resistor to the positive terminal of the output power supply. The maximum current is 50mA.
Pend-	Pend- is connected to the negative terminal of the output power supply.
ALM+	When overcurrent, overvoltage, undervoltage or position error alarm, the alarm signal is valid (output optocoupler is on). ALM+ is connected to the pull-up resistor to the positive terminal of the output power supply. The maximum drive current is 50mA.
ALM-	ALM- is connected to the negative terminal of the output power supply.
PWR	Power Indicator. Power on, green light is always on
ALM	Fault indicator. Flash once: overcurrent or phase-to-phase short circuit; Flashing twice: over voltage; Flashing three times: under voltage; Flashing five times: following position error

### 3.2 Connector P2 Configurations

Pin Function	Details
GND	Power ground.
+V	Power supply, CL57Y:DC24~50V; CL86Y:AC20~80V/DC30~110V
A+, A-	Motor phase A
B+, B-	Motor phase B

### 3.3 Connector P3 Configurations

Pin Name	Description
EB-	Encoder B- input
EB+	Encoder B+ input
EA+	Encoder A+ input
EA-	Encoder A- input
VCC	+5V power output
EGND	Signal ground

## 4 Wiring

The CL57Y、CL86Y can accept differential and single-ended inputs (including open-collector and PNP output). The CL57Y、CL86Y has 4、5 optically isolated logic inputs which are located on connector P1 to accept line drive control signals. These inputs are isolated to minimize or eliminate electrical noises coupled with the drive control signals. Recommend using line drive control signals to increase noise immunity for the drive in interference environments.

A complete closed loop stepper system should include a closed loop motor, a drive, a power supply and a controller (pulse generator). The typical connection is shown as figure 3.

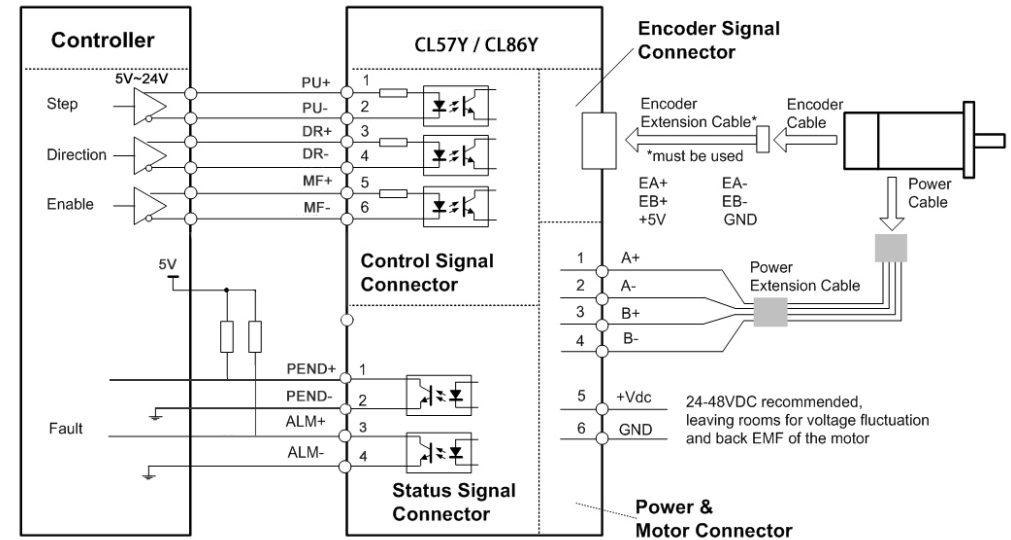

Figure 3: Typical connection

## 5 Motor Wiring

### 5.1 Connections of 4-lead Motor

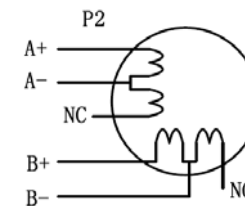

Figure 4: 4-lead Motor Connections

### 5.2 Connections of 6-lead Motor

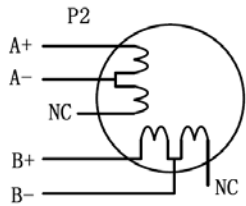

Figure5: 6-lead motor half coil (higher speed) connections

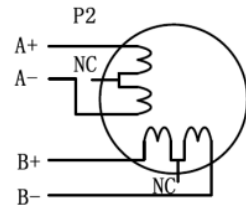

Figure 6: 6-lead motor full coil (higher torque) connections

### 5.3 Connections of 8-lead Motor

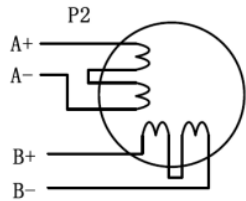

Figure 7: 8-lead motor series connections

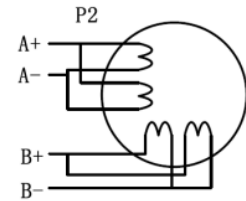

Figure 9: 8-lead motor parallel connections

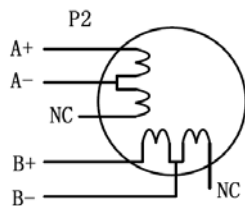

Figure10: 8-lead motor half coil

### 6 Frequently Asked Questions

Symptoms	Possible Problems
Motor is not rotating	No power
	Microstep resolution setting is wrong
	Fault condition exists
	The drive is disabled
Motor rotates in the wrong direction	The Direction signal level is reverse
The drive in fault	Power supply voltage beyond drive's input range
	Something wrong with motor coil
	Wrong connection
Erratic motor motion	Control signal is too weak
	Control signal is interfered
	Wrong motor connection
	Something wrong with motor coil
Motor stalls during acceleration	Current setting is too small
	Motor is undersized for the application
	Acceleration is set too high
	Power supply voltage too low
Excessive motor and drive heating	Inadequate heat sinking / cooling
	Current is set too high
Motor vibration when power on	Speed loop Kp is too high

### 7 Warranty

OYOSTEPER warrants its products against defects in materials and workmanship for a period of 12 months from shipment. During the warranty period, StepperOnline will either, at its option, repair or replace products which proved to be defective. To obtain warranty service, a returned material authorization number (RMA) must be obtained before returning product for service.

**Exclusions:** The above warranty does not extend to any product damaged by reasons of improper or inadequate handlings by customer, improper or inadequate customer wirings, unauthorized modification or misuse, or operation beyond the electrical specifications of the product and/or operation beyond environmental specifications for the product.